

DILLON



Dynaswitch & Cranegard User's Manual

Table of Contents

Section 1 Dynaswitch General Information	5
1-1 Introduction	5
1-2 General Description	5
1-3 Safety	5
1-4 Compression Models	5
1-5 Tension Models	5
1-6 Key Specifications and Options	6
1-7 Microswitches	7
1-8 Attachment Fittings	8
Section 2 Installation	9
2-1 Mounting Positions Tension Models	9
2-2 Mounting Positions Compression Models	9
2-3 Dynaswitches & Reeving Setups	10
2-4 Other Installation Possibilities	11
2-5 Dynaswitch Selection	12
2-6 Dynaswitch Field Installation Procedures	12
2-6-A Wiring the Compression Model Dynaswitch	12
2-6-B Wiring the Tension Model Dynaswitch	12
2-6-C Setting the Set Points	13
Section 3 Operation	15
3-1 Safety Shutdown Function	15
3-2 Decreasing Load Operation	15
3-3 Automation Operation	15
Section 4 Maintenance	15
4-1 General Instructions	15
4-2 Service Instructions	15
4-3 Authorized Replacement	16
4-4 Troubleshooting	16
Section 5 Cranegard Load Limit Switch	17
5-1 Introduction	17
5-2 General Description	17
5-3 Safety Factor	17
5-4 Microswitches	17
5-5 Key Specifications	17
Section 6 Installation	18
6-1 Mounting Positions	18
6-2 Selection	18
6-3 Cranegard Field Installation Procedures	19
6-4 Electrical Wiring	19
Section 7 Maintenance	20
7-1 General Instruction	20
7-2 Mechanical Inspection	20
7-3 Electrical Inspection	20
7-4 Switch Setting	20
7-5 Authorized Parts Replacement	20
7-6 Troubleshooting	20

Pages are numbered consecutively beginning with the cover page.

Section 1: Dynaswitch General Information

1-1 Introduction

The primary purpose of Model DS Dynaswitches® is to protect cranes, hoists and other lifting machinery against weight or force overload damages. They can also be used to perform control functions proportional to weight such as shutting down a pump when a tank is filled. As many as four standard microswitches can be installed on the Dillon Dynaswitch to perform multiple automated functions. The Dynaswitch is intended for applications with gradually applied loads and should not be installed where it may encounter severe dynamic or impact loads.

1-2 General Description

Dillon Dynaswitches are designed to work with either a tension or compression load. All Dynaswitches consist of a U-shaped force beam, a microswitch (or microswitches), and attachment fittings for applying load at mounting points. The force beam bends as force is applied and causes the microswitches to open or close electrical circuits. Illustrations on pages 7 and 8 show various microswitches and attachment fittings. Dynaswitch capacity should be selected based on maximum forces it may encounter, including load-increasing factors such as acceleration of mass and static arrangement of cables.

1-3 Safety

All Dynaswitch force beams and attachment fittings have a safety factor of 5:1. In addition, all models have an overload stop, set slightly in excess of rated capacity to prevent damage to measuring capability.

1-4 Compression Models

When loads are applied to compression models, the force beam legs tend to come closer together. Paragraph 2-6-A explains how to hook up safety overload circuits and auxiliary circuits of compression models' microswitches. Compression models contain threaded holes on the bottom leg for mounting to machinery and a spherical bearing on the top leg to concentrate the applied load at one point. The stops for measuring capability protection are adjustable bolts in all capacities except 25K and 50K, where this stop is integral with the force beam.

1-5 Tension Models

When loads are applied to tension models, the force beam legs tend to spread apart. Paragraph 2-6-B explains how to hook up safety overload circuits and auxiliary circuits to tension models' microswitches. Tension model attachment fittings include spherical rod end connectors, shackles, lifting eyes, non-swivel hooks and threadstuds. Attachment fittings are mounted on opposite legs and are in-line axially so the applied load will not cause rotation of the beam. The stops for measuring capability protection are adjustable bolts in all capacities.

1-6 Key Specifications and Options

Table 1-1, below, contains key specifications and options available.

Table 1-1

Basic Beam Part Number	DSW-1	DSW-2	DSW-3	DSW-4	DSW-5	DSW-6	DSW-7
Rated Capacity pounds	100	1000	2000	5000	10000	25000	50000
Minimum Set point*	15	100	200	500	1000	1250	2500
Repeatability pounds	±3	±30	±60	±150	±300	±750	±1500
Nomi--l full Cap. beam deflection in inches	0.02	0.03	0.05	0.05	0.05	0.06	0.06
Switch	Option A	Avail.	Avail.	--	Avail.	--	--
	Option J	Avail.	Avail.	--	Avail.	--	--
	Option B	--	--	Avail.	--	Avail.	Avail.
	Option C	--	--	Avail.	--	Avail.	Avail.
Hardware	Option D	Avail.	Avail.	--	--	--	--
	Option E	Avail.	Avail.	Avail.	Avail.	Avail.	Avail.
	Option F	--	--	Avail.	--	Avail.	--
	Option G	--	--	Avail.	Avail.	Avail.	Avail.
	Option H	--	--	Avail.	--	Avail.	--
	Option S	Avail.	Avail.	Avail.	Avail.	Avail.	Avail.

- Option A .001" differential travel switch; small size. P/N 26419-0026 Type 11SM401-T. Maximum 4 per unit.
- Option J .004" differential travel switch; weatherproof, small size. 26420-0015 . Type 1SE1. Maximum 4 per unit.
- Option B .002" differential travel switch; weatherproof. P/N 17891-0048 Type BZG1-2RN. Maximum 4 per unit.
- Option C Explosion proof switch. 26424-0029. Type EXA-0. Maximum 2 per unit.
- Option D Spherical rod end connector (one).
- Option K Compression loading spherical ball fitting assembly (one).
- Option F Lifting eye (one)
- Option G Adapter, shackle & pin (one set).
- Option H Non-swivel hook (one).
- Option S Stud for tension loading (one).

Microswitches

Below are the four microswitches available and their specifications.

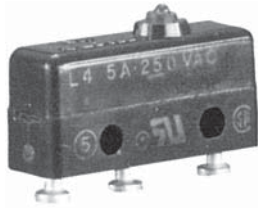

Option A:

0.001" differential travel switch.
Small size
Dillon PN 26419-0026
(Cat. #11SM401-T.) S.P.D.T.
5 amps. resistive at 28VDC or
250VAC

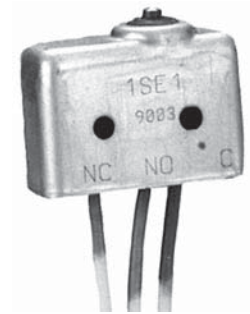

Option J:

0.004" differential travel switch
Small size
Weatherproof
Dillon PN 26420-0015
(Cat. #1SE1.) S.P.D.T.
5 amps. resistive at 28VDC, 125 or
250VAC



Option B:

0.002" differential travel switch
Weatherproof
Dillon PN 17891-0048
(Cat. #BZG1-2RN.) S.P.D.T.
15 amps. resistive at 125, 250 or
480VAC. ½ amp. at 125VDC.

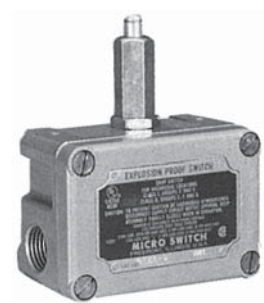

Option C:

0.060" differential travel switch
Explosion proof
Dillon PN 26424-0029
(Cat. #EXA-Q.) S.P.D.T.
20 amps. resistive at 125, 250 or
480VAC. ½ amp. at 125VDC.

1-8 Attachment Fittings

Attachment fittings for tension and compression models are shown below. Illustrations are not to scale.



Option D:
Spherical rod end connector



Option E:
Compression loading spherical ball fitting assembly



Option F: Lifting eye



Option G:
Adapter, shackle and pin (one set)



Option H:
Nonswivel hook



Option S:
Threaded stud

Section 2 Installation

2-1 Mounting Positions Tension Models

The best mounting position for a tension model is on the dead end of the line or on a crane anchor point. This mounting minimizes the effects of the machinery's motion on the Dynaswitch. It keeps the switch in one relative position which reduces the possibility of wire tangling and connector damage.

2-2 Mounting Positions Compression Models

Some compression models have flat-top balls; rest the applied load on the flat surface of the flat-top ball.

Position the Dynaswitch so that all of the supported load is transmitted through the compression ball fitting. Bolt the bottom leg to the loading machinery or the facility foundation. Make sure the load contacts the Dynaswitch only at the top of the steel ball and nowhere else! If the load rests on the upper leg as well as on the ball, the microswitches will not actuate at the proper load setting. Do not restrict free motion of the upper leg since this too could cause the Dynaswitch to activate improperly.

2-3 Dynaswitches & Reeving Setups

Below are some examples of hoist and reeving setups which use the Dynaswitch for control and/or safety purposes.

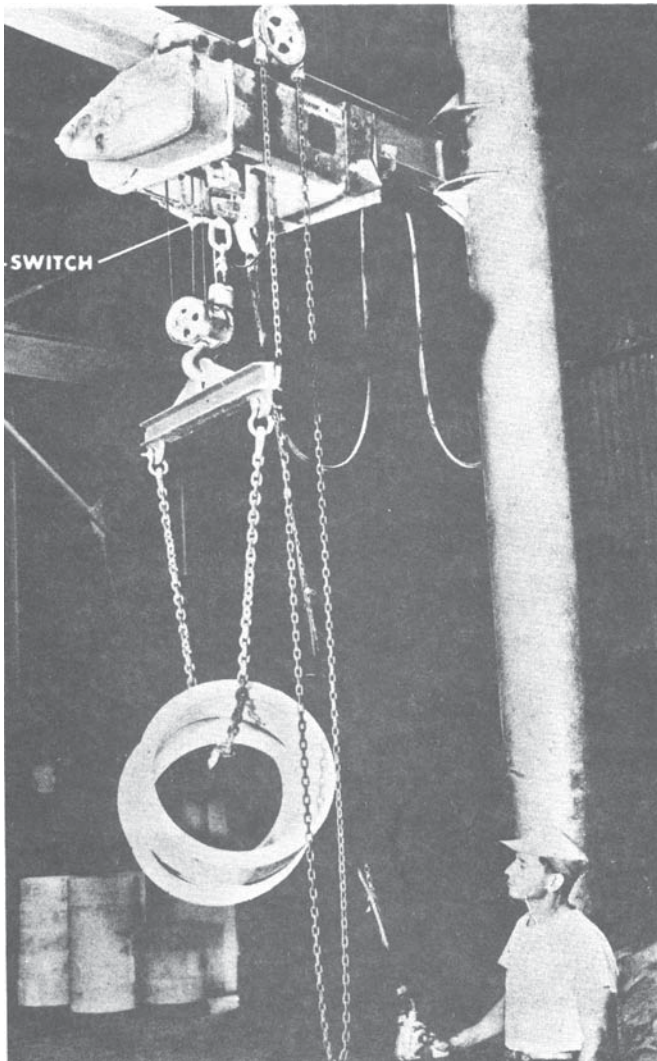

Figure 2-B

As shown at right, Dynaswitch is installed in series with rope to the dead end. The microswitch is set for $\frac{1}{4}$ capacity of the crane because there are four parts of line to the hook.

Frictional reactions within the sheaves may prevent all parts of the lines from having identical tension. While generally suitable for overload protection, it may give unsatisfactory results for weighing or batch control.

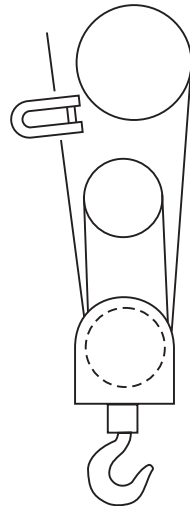

Figure 2-C
4 ropes, 4 part single
reeving

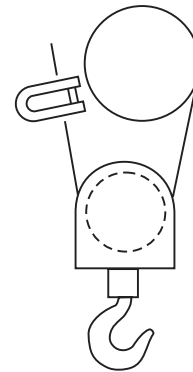

Figure 2-A
2 ropes, 2 part single
reeving

With two parts of line to the hook, the Dynaswitch should be installed in series between wire rope and its dead end point. Microswitch is set for $\frac{1}{2}$ maximum capacity of the hoist.

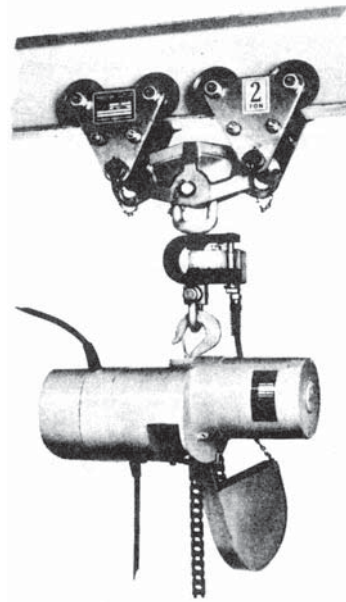

Figure 2-D

The Dynaswitch may also be placed between hoist and trolley with microswitch set for maximum capacity of the hoist and trolley.

2-4 Other Installation Possibilities

Figure 2-E and 2-F show other uses for the Dynaswitch when either tension or compressions loads are present.

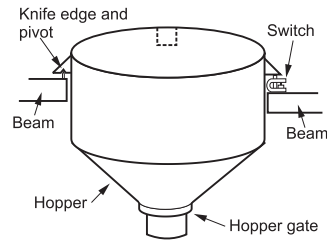

Figure 2-E

Batching operations at preset load points are greatly simplified by means of economical Dillon Dynaswitches. Figure 2-E shows a typical hopper with 3 point suspension. Dynaswitch under one suspension point is set for 1/3 maximum load. It opens hopper gate automatically at this point. Contents of tank should preferably be liquid, since solid materials tend to pile and cause erroneous results.

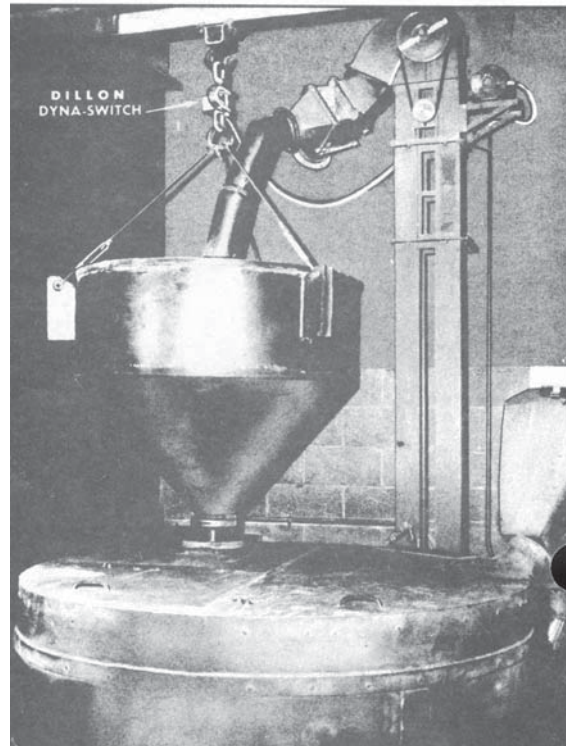

Figure 2-F

Figure 2-F shows an example of using the Dynaswitch in an automatic control function. Sand used in foundry operations is brought up from the floor below by conveyor. It falls into the chute and then spills into the hopper. The hopper itself is suspended from the Dynaswitch at upper left. The Dynaswitch is set to open the conveyor motor circuit at 1000 pounds which represents a full hopper. At the same instant, a trap in the bottom of the hopper also opens permitting contents to flow out into a mixer below. A time delay switch on the hopper trap holds it open until all sand has been discharged at which time the reduced load on the Dynaswitch causes it to again close the conveyor motor circuit and repeat the cycle endlessly. The Dynaswitch is also acting as a precision scale since it is set to function at a specific load point. Any form of batching operation can be easily automated by this simple arrangement.

2-5 Dynaswitch Selection

To pick the proper sized Dynaswitch for the job, do the following:

1. Determine the mounting position.
2. Calculate the load to be applied to the Dynaswitch.
3. Refer to Table 1-1 to select a Dynaswitch with the proper capacity and minimum/maximum set point range.

2-6 Dynaswitch Field Installation Procedures

Loads applied to compression Dynaswitches cause the force beam legs to deflect and come closer together. Loads applied to tension units cause the force beam legs to deflect outward and spread apart. Microswitches are S.P.D.T. and have three contact terminals. One is normally open, one normally closed, and one is common. Therefore they can be wired to make or break a circuit at specific set point(s).

2-6-A Wiring the Compression Model Dynaswitch

To **make** a circuit:

1. on **increasing** compression load, use common and normally open contacts.
2. on **decreasing** compression load, use common and normally closed contacts.

To **break** a circuit:

1. on **increasing** compression load, use common and normally closed contacts.
2. on **decreasing** compression load, use common and normally open contacts.

2-6-B Wiring the Tension Model Dynaswitch

You can put together a test assembly consisting of an indicator light or horn, a power source and two leads with alligator clips to simulate the machinery's control circuit.

To **make** a circuit:

1. on **increasing** tension load, use common and normally closed contacts.
2. on **decreasing** tension load, use common and normally open contacts.

To **break** a circuit:

1. on **increasing** tension load, use common and normally open contacts.
2. on **decreasing** tension load, use common and normally closed contacts.

Any time the Dynaswitch is removed from the machinery and reinstalled, you must check the switch operation. Failure to do so could result in inaccurate actuation as the calibration could change.

2-6-C Setting the Set Points

1. Figure the desired set point, in pounds, for each microswitch. In setting two, three or four switches, set the highest set point first, then work down according to weight. Any other sequence will cause a shutdown during the adjusting process.
2. Turn the adjustment screw:
 - In compression models, back the adjustment screw as far as it will go away from the switch plunger.
 - In tension models, turn the adjustment screw as far as it will go into the switch plunger without damaging the switch.
3. Apply a load on the unit equal to the desired setting. You must apply an accurately measured load because the set point accuracy will be no better than the known accuracy of the measured load.
4. Slowly turn the adjustment screw:
 - In compression, turn the screw until it is just low enough to actuate the switch. Then tighten the jam nut to hold the adjustment.
 - In tension, turn the screw until it is just high enough to actuate the switch plunger. Then tighten the jam nut to hold the adjustment.
5. Remove, then reapply the load to check the set point. It is properly set if the machinery, or the test assembly, functions as planned within desired tolerances.
6. Repeat steps 1-5 as many times as required to obtain correct settings.

Your Dynaswitch is now ready to use. It is recommended that you double check your installation before beginning operation.

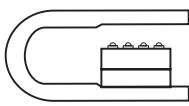
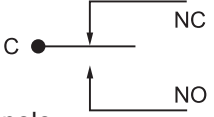
Low Differential Travel Switch (For 100, 1,000 and 5,000 lb beams only)		
	Circuitry	Electrical Data
	 <p>Single pole Double throw</p>	UL Rating: 5 AMPS, 125 or 250VAC

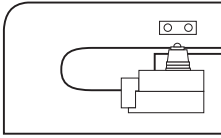
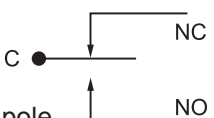
Weatherproof Low Differential Travel Switch (For 2,000, 10,000, 25,000 and 50,000 lb beams only)		
	Circuitry	Electrical Data
	 <p>Single pole Double throw</p>	UL Rating: L 74 15 AMPS, 125, 250 or 480 VAC; 2 AMPS, 600 VAC; 1/8 HP, 125 VAC; 1/4 HP, 250 VAC; .5 AMPS, 125 VDC; .25 AMP 250 VDC.

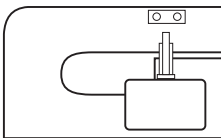
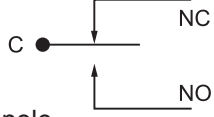
Explosion-Proof Switch (For 2,000, 10,000, 25,000 and 50,000 lb beams only)		
	Circuitry	Electrical Data
	 <p>Single pole Double throw</p>	UL Rating: L 23 20 AMPS, 125, 250 or 480 VAC; 10 AMPS, 125 VAC "L"; 1 HP, 125 VAC; 2 HP, 250 VAC; .5 AMPS , 125 VDC; .25 AMP 250 VDC.

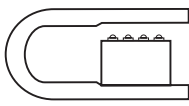
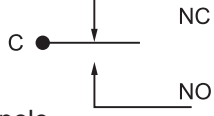
Weatherproof Low Differential Travel Switch (For 100, 1,000 and 5,000 lb beams only)		
	Circuitry	Electrical Data
	 <p>Single pole Double throw</p>	5 AMPS Res., 3 AMPS Ind., (Sea level), 4 AMPS Res., 2 AMPS Ind., (50,000 feet) 28 VDC 5 AMPS Res. or Ind. 115 VAC, 60 Hz. UL/CSA Rating: 5 AMPS, 250 VAC.

Section 3 Operation

3-1 Safety Shutdown Function

DO NOT override the safety shutdown circuit. This can result in injury to workers and damage to equipment.

3-2 Decreasing Load Operation

Ensure that the Dynaswitch triggers both the increasing and decreasing load function as planned. Stop the machinery and adjust the switch or setup if a problem exists.

3-3 Automation Operation

Ensure the automated machinery setup is working properly. If it is not, stop the machinery and adjust either the Dynaswitch or the other components of the setup until it does work properly.

Section 4 Maintenance

4-1 General Instructions

Service the Dynaswitch at least once every six months (more often if it is exposed to extreme climate or working conditions) according to paragraph 4-2, below. In addition, check the accuracy of the microswitch at least once every six months (more often if it is part of a setup which receives frequent use) and reset the microswitch as required. Switch setting procedures are outlined in paragraph 2-6.

4-2 Service Instructions

- A. Attachment Fittings - Check for unusual wear, deformation, looseness and corrosion. Replace if damaged or loose. Clean off corrosion; oil compression steel ball fitting as required.
- B. Micro-Switches - Replace if wires are frayed or if the connection plunger or housing is damaged in any way.
- C. Overload Stop - Make sure no foreign material is present in overload stop gap, since this could cause errors.
- D. Adjustment screws, overload devices, switch and screw mounting brackets - Replace the component if it is damaged or deformed enough not to work as designed.
- E. Force Beams - Cleaning corrosion and painting are the only authorized services. If the force beam has suffered damage or permanent deformation, replace the entire Dynaswitch.

4-3 Authorized Replacement

- A. Attachment Fittings - The customer is authorized to replace only shackle and pin attachment fittings at their facility. Customers desiring replacement of any other attachment fitting must return the Dynaswitch to Dillon or a factory authorized distributor for attachment fitting replacement. The reason for this is that all attachment fittings other than shackles and pins are pinned to the force beam after assembly.
- B. Microswitches - Addition and replacement of microswitches, as well as conversion from one type to another is authorized as long as the user orders the proper Dillon microswitches. Microswitch mounting brackets and adjustment screw mounting brackets are available for all authorized configurations. Switch calibration is required after such service.
- C. Other Parts - The replacement of parts other than shackle and pin attachment fittings, authorized microswitches and microswitch mounting hardware is not authorized. Attempting to make unauthorized repairs on the Dynaswitch automatically voids the Dillon warranty.

4-4 Troubleshooting

Problems are generally limited to the Dynaswitch actuating too soon, too late or not at all.

Recommended troubleshooting procedure:

- A. Ensure there is power to the circuits involved.
- B. Reset the microswitches.
- C. Check the microswitch and the circuit for continuity.
- D. Check the functions of the machinery setup (for items that would cause improper actuation).

Most problems will be found in one of these areas.

Excessive wear in attachment fittings is caused by excessive loading, improper installation or abnormal machinery travel. Replace damaged fittings and correct the machinery installation or loading problem.

Section 5 Cranegard® Load Limit Switch

5-1 Introduction

The Dillon Cranegard Load Limit Switch is used to protect cranes and hoists against overloading where it is impossible or inconvenient to use a Dillon Dynaswitch. This unit can be applied to wire rope without cutting or removing the dead end from its existing mount. It may also be used on machinery such as elevators to provide a switch action at a given load. The Cranegard is intended for applications with gradually applied tensions and not dynamic or impact loads.

5-2 General Description

The Dillon Cranegard Load Limit Switch is designed to clamp directly onto typical hoist or crane rope. It consists of two side plates. Two steel sheaves which are equipped with precision bearings, a rope clamp and center support which in turn is attached to a flexure. Arm(s) on the flexure can actuate as many as four microswitches at preset load points. Adjustment screws for the switches are located under a sealed cover.

5-3 Safety Factor

The Dillon Cranegard Load Limit Switch flexure beam has a safety factor of 2:1. Ultimate safety factor is a function of wire rope condition. In the interest of safety, damaged or worn wire rope should be replaced.

5-4 Micro-Switches

The microswitch is type BZG1-2RN, weatherproof, Dillon P/N 17981-0048 (paragraph 1-7). As many as four switches can be installed on one Cranegard unit.

5-5 Key Specifications

Table 5-1, below, indicates capacities and other specifications.

Part Number	Capacity Pounds	Min. Set Point Lb	Repeatability Pounds	Rope Diameter Inches	
				Minimum	Maximum
CGS-1	2500	100	75	3/16	1/2
CGS-2	5000	200	150	3/8	7/8
CGS-3	10000	400	300	7/16	7/8
CGS-4	20000	800	400	5/8	1 1/4

Section 6 Installation

6-1 Mounting Positions

The best mounting position for the Cranegard Load Limit Switch is adjacent to the wire rope dead end point. It also could be installed adjacent to the equalizer sheave where wire rope movement is small (a few inches). The amount of wire rope movement around the equalizer sheave should be measured by marking the wire rope, noting the amount of movement, and allowing enough clearance for such movement when mounting the Cranegard unit.

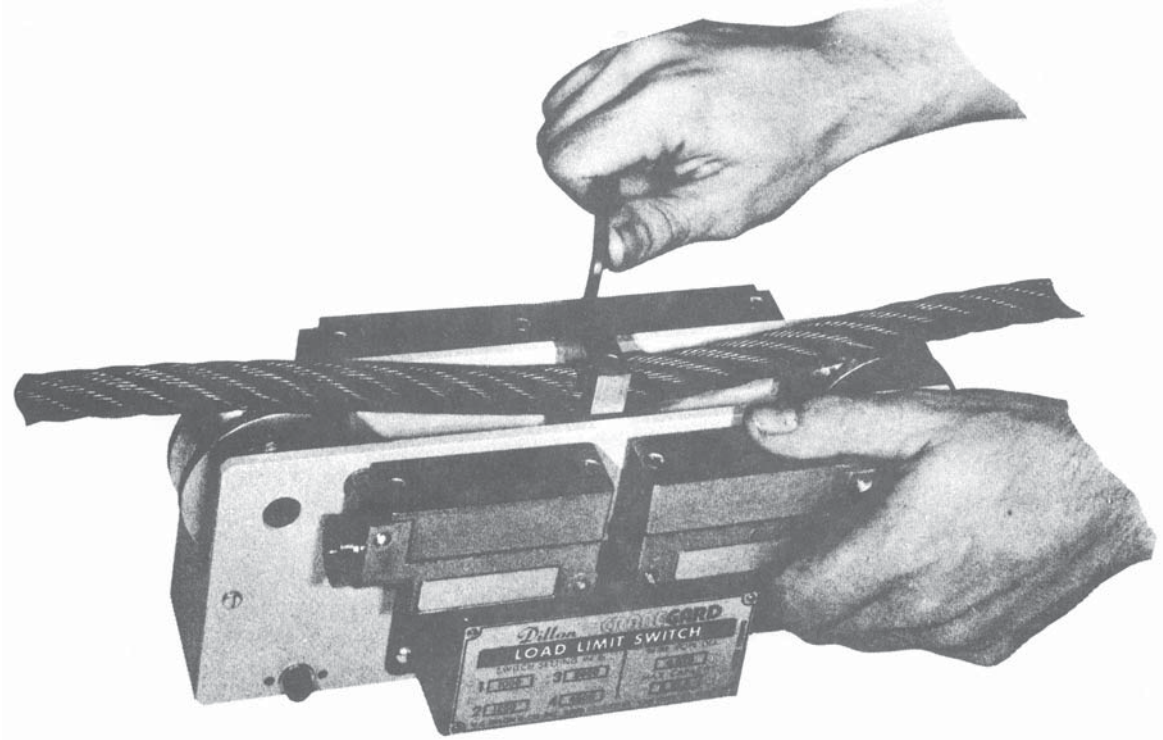

Figure 6-A

6-2 Selection

To pick the proper size Cranegard Load Limit Switch for the job, do the following:

- A. Measure the diameter of the rope on which the Cranegard Load Limit Switch is to be installed.
- B. Calculate the maximum load to be applied to the Cranegard Load Limit Switch, using capacity of the hoist or crane and number of parts of line to the hook (refer to 2-3).
- C. Choose the number of switches and set point.
- D. Refer to table 5-1 for proper selection.

6-3

Cranegard Field Installation Procedures

- A. The Cranegard is designed to be mounted on a slack line. If line is not slack, methods should be employed to shunt load in the cable area where Cranegard will be installed. Often wire grips and portable winches are used to accomplish this.
- B. Position the Cranegard at the desired location on wire and loosely attach the clamp with the included screws. Tighten the screws so that the cable is loosely gripped between the top and the bottom of the clamp. Insure the same gap exists between the upper and lower clamps on both sides.
- C. Check switch operation using a voltmeter or other method for monitoring open/closing of switch contacts. If specific loads were indicated at the time of order, Dillon will calibrate to these values at the factory prior to shipment. Once installed, there may be differences between calibration and actual trigger values. Differences in rope type & diameter, temperature, and external mechanisms (such as sheaves) can affect the switch activation points. If more precise calibration is required, it should be calibrated under the conditions used.
- D. If field calibration is required, follow the additional instructions below.
- E. Remove the protective cover to expose adjustment screws.
- F. Refer to Paragraph 2-6, Notes 1 and 2, for information on construction of a test assembly for switch adjustment.
- G. Figure the desired set point for each microswitch. In setting two, three or four switches, set the highest set point first, then work down according to weight. Any other sequence will cause a shutdown during the adjusting process.
- H. Turn the adjustment screw(s) counterclockwise, away from the microswitch plunger(s) as far as possible.
- I. Apply the trigger load, insuring that the cutoff load is approached from the desired direction. For increasing loads, such as overload detection, gradually apply the load. For decreasing loads, such as slack-line detection, apply at least 5% more load (of Cranegard capacity) than is desired for switch trigger, then gradually reduce the load until trigger load is reached.
- J. Slowly turn the adjustment screw until it contacts the microswitch plunger and the switch actuates. Then tighten the jam nut to hold the adjustment.
- K. Remove, then reapply the load to check the set point. It is properly set if the machinery (or the test assembly) functions as planned within desired tolerances.
- L. Repeat steps G through K as many times as required to obtain correct settings.

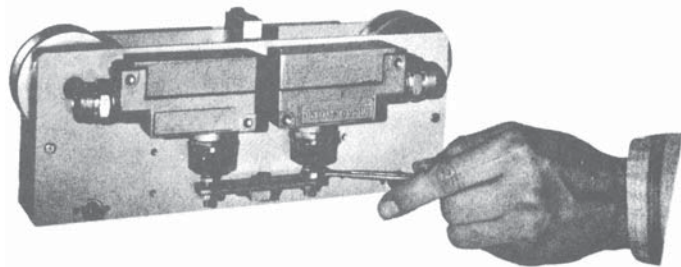

Figure 6-B

6-4 Electrical Wiring

Any time the Dynaswitch is removed from the machinery and reinstalled, you must check the switch operation. Failure to do so could result in inaccurate actuation as the calibration could change.

Micro-switch(es) are S.P.D.T. and have three contacts. One is normally open, one normally closed, and one is common. Therefore they can make or break a circuit (start or stop an operation) at a specific set point(s).

To BREAK a circuit at a set point as load increases, select normally closed and common switch terminals. To MAKE a circuit as load increases, wire to normally open and common terminals.

To BREAK a circuit at a set point as load decreases, wire to common and normally open terminals. To MAKE a circuit as load decreases, wire to common and normally closed terminals.

Section 7 Maintenance

7-1 General Instruction

Depending on environmental and working conditions, Cranegard Load Limit Switches should be inspected periodically, at least every six months.

7-2 Mechanical Inspection

Cranegard Load Limit Switches should be free from any contact friction of adjacent wire rope.

7-3 Electrical Inspection

Check for frayed wires, damage to the microswitch housing and protective cover.

7-4 Switch Setting

Check established operating setting(s). If necessary, the switches should be reset.

7-5 Authorized Parts Replacement

Type BZG1-2RN microswitches are the only authorized parts replacements for Cranegard Load Limit Switches. Attempting to make unauthorized repairs to the Cranegard Load Limit Switch automatically voids the Dillon warranty.

7-6 Troubleshooting

Follow the procedure for the Dynaswitch in section 4-4.

Dillon

A division of Weigh-Tronix Inc.
1000 Armstrong Dr.
Fairmont, MN 56031 USA
Telephone: 507-238-4461
Facsimile: 507-238-8258
e-mail: dillon@weigh-tronix.com
www.dillon-force.com

DILLON

Force Measurement Products & Systems